



- Power over Ethernet
- IEEE 1588 PTP
- Trigger over Ethernet
- Compact design

Small and powerful

Ultra-compact GigE Vision cameras

Mako G-511 with Sony IMX547 runs 23.0 frames per second at 5.1 MP resolution.

Mako is an attractively priced GigE Vision-compliant camera in a compact rugged industrial housing. Many models include advanced functionalities such as Precision Time Protocol (PTP), Trigger over Ethernet (ToE) Action Commands, and Power over Ethernet (PoE). Screw mount RJ45 connector and multiple I/Os facilitate your straightforward system integration. Mako cameras are also available as Near Infrared (NIR) and polarizer variants.

Easy software integration with Allied Vision's [Vimba Suite](#) and compatibility to the most popular [third party image-processing libraries](#).

See the [Modular Concept](#) for lens mount, housing variants, optical filters, case design, and other modular options. See the [Customization and OEM Solutions](#) webpage for additional options.

Specifications

Interface	IEEE 802.3 1000BASE-T, IEEE 802.3af (PoE)
Resolution	2472 (H) × 2064 (V)
Sensor	Sony IMX547
Sensor type	CMOS
Shutter mode	Global shutter
Sensor size	Type 1/1.8
Pixel size	2.74 μm × 2.74 μm
Lens mounts (available)	C-Mount, CS-Mount
Max. frame rate at full resolution	23 fps
ADC	12 Bit
Image buffer (RAM)	64 MByte

Imaging performance

Imaging performance data is based on the evaluation methods in the EMVA 1288 Release 3.1 standard for characterization of image sensors and cameras. Measurements are typical values for monochrome models measured at full resolution without optical filter. Contact Sales or AE for more information.

Quantum efficiency at 529 nm	70 %
Temporal dark noise	2.4 e ⁻
Saturation capacity	9341 e ⁻
Dynamic range	69.9 dB
Absolute sensitivity threshold	3.0 e ⁻

Output

Bit depth	12 Bit
Monochrome pixel formats	Mono8, Mono12, Mono12Packed
YUV color pixel formats	YUV411Packed, YUV422Packed, YUV444Packed
RGB color pixel formats	RGB8Packed, BGR8Packed
Raw pixel formats	BayerRG8, BayerRG12, BayerRG12Packed

Features

Image control: Auto

- Auto exposure
- Auto gain
- Auto white balance (color models)

Image control: Other

- Binning
- Black level
- Color transformation (incl. hue, saturation; color models)
- Decimation
- Gamma
- LUT (look-up table)
- Reverse X/Y
- ROI (region of interest)

Camera control

- Acquisition frame rate
- Action commands, incl. ToE (trigger over Ethernet)
- Bandwidth control
- Event channel
- Firmware update in the field
- I/O and trigger control
- Image chunk data
- PTP (IEEE 1588 Precision Time Protocol)
- Stream hold
- Temperature monitoring
- User sets

Technical drawing

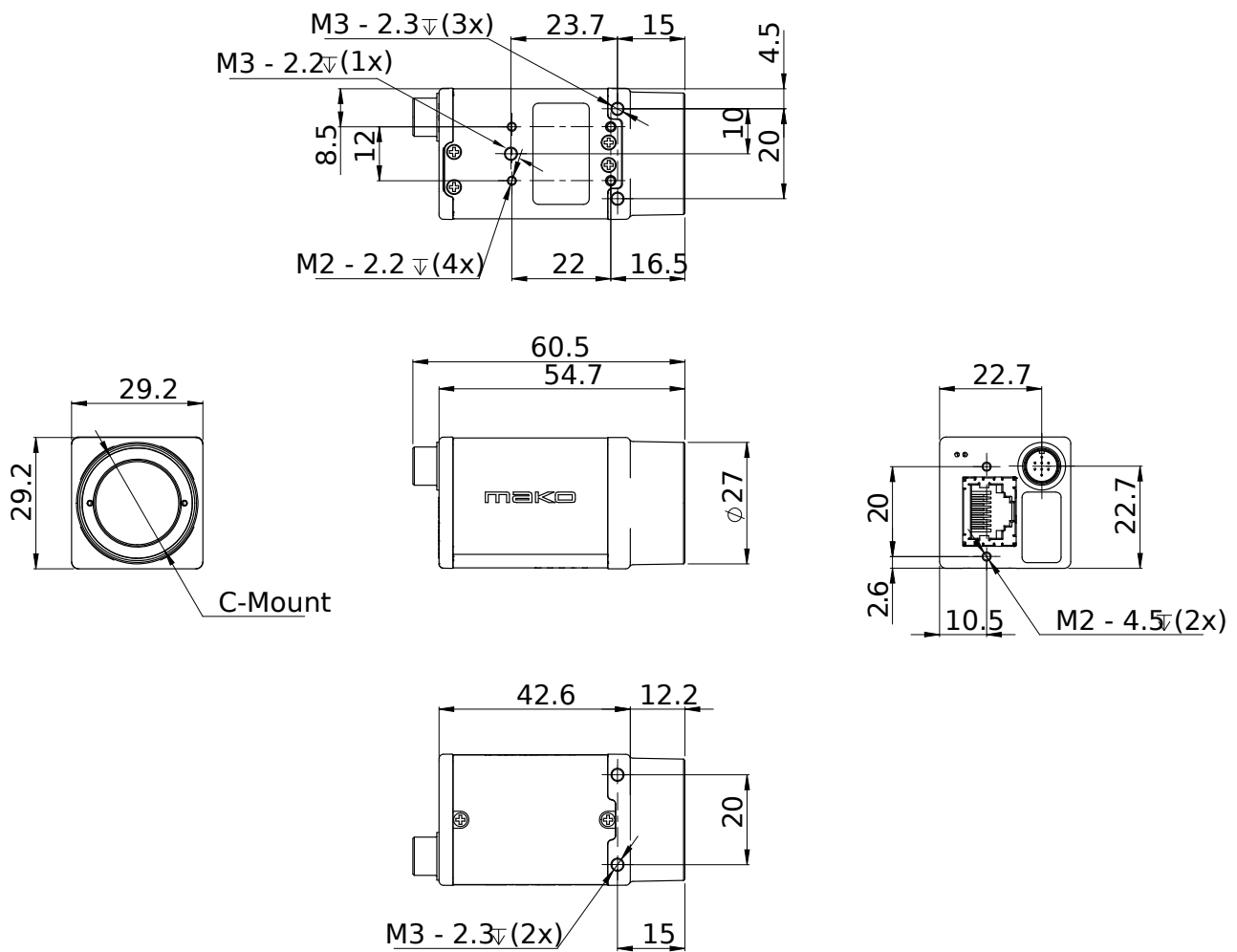

Applications

Mako G is suitable for all typical applications in machine vision:

- Robotics
- Quality control
- Inspection, surveillance
- Industrial imaging
- Machine vision
- Logistics